

输出轴

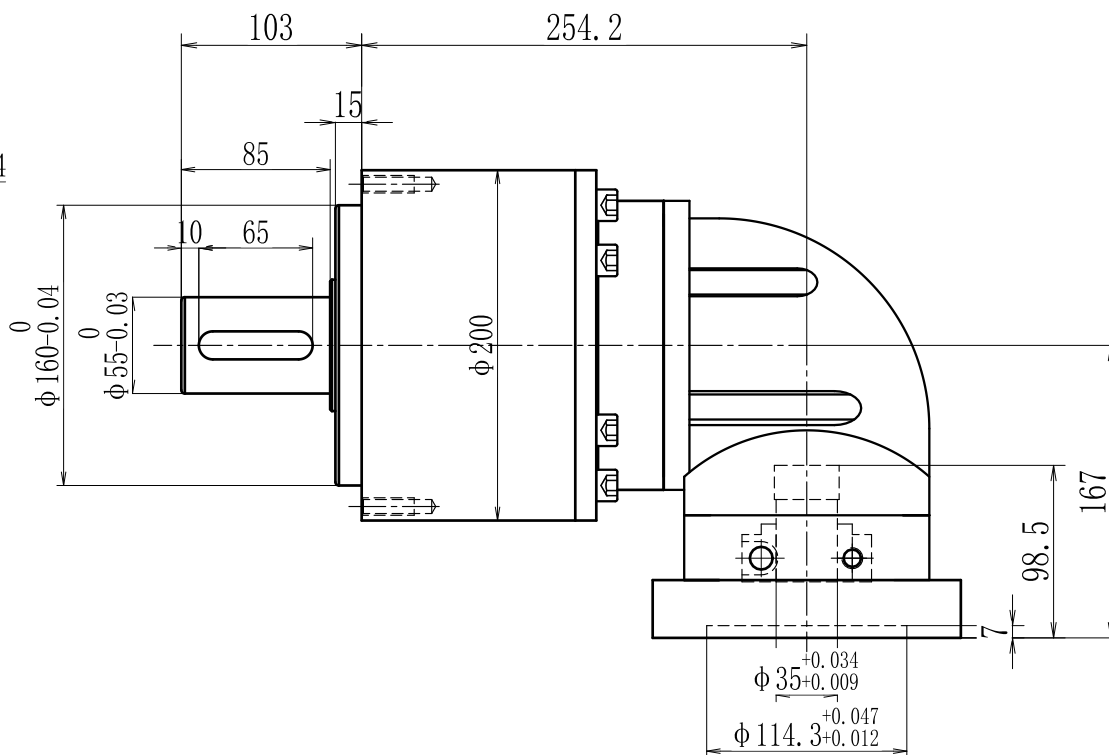

输入轴

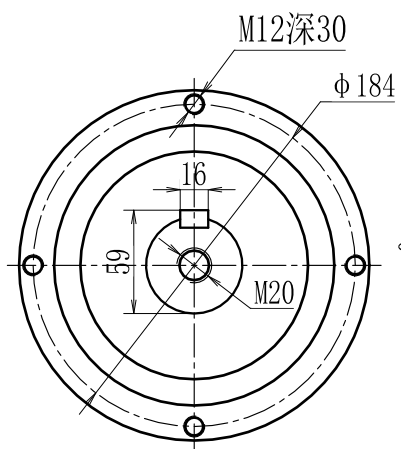
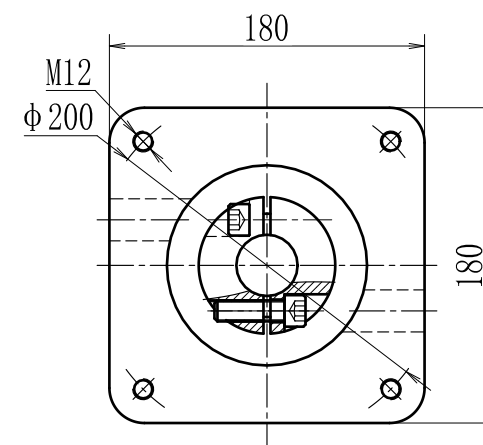

型号 model	EVL205-L2-K-9-180		
速比 ratio	1:9-1:200	承受扭矩 Bear torque	700-1650Nm
背隙 precision	9arcmin	输入转速 Input speed	2000r/min
噪音 noise	70dB	重量 weight	60kg



帝悦精密科技(苏州)有限公司

YUE DI PRECISION TECHNOLOGY (SUZHOU) CO., LTD.

精密行星减速机
Precision planetary reducer

电话(Call): 0512-53127777
网址(http): WWW.DEU-GAM.COM