

输出端

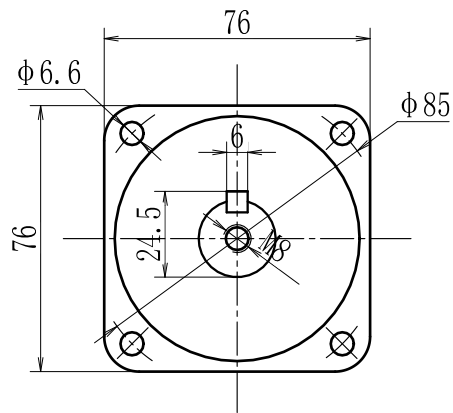

输入端

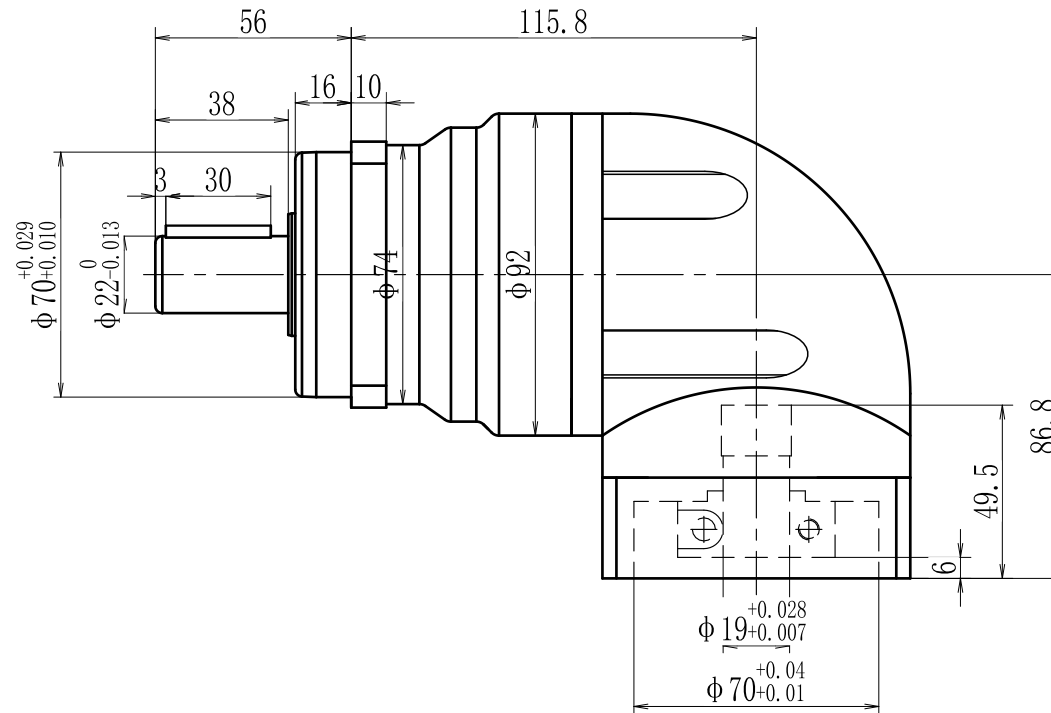
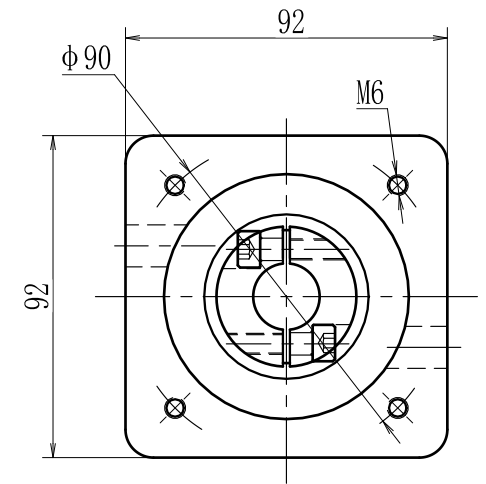

型号 model	EVS75-L1-K-6-80		
速比 ratio	1:3-1:20	承受扭矩 Bear torque	75-165Nm
背隙 precision	6arcmin	输入转速 Input speed	3000r/min
噪音 noise	60dB	重量 weight	5.5kg



帝悦精密科技(苏州)有限公司

YUE DI PRECISION TECHNOLOGY (SUZHOU) CO., LTD.

精密行星减速机

Precision planetary reducer

电话(Call): 0512-53127777

网址(http): WWW.DEU-GAM.COM