

输出端

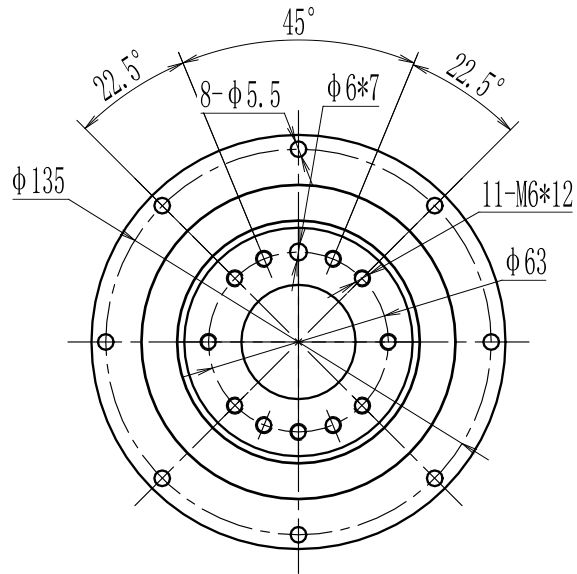

输入端

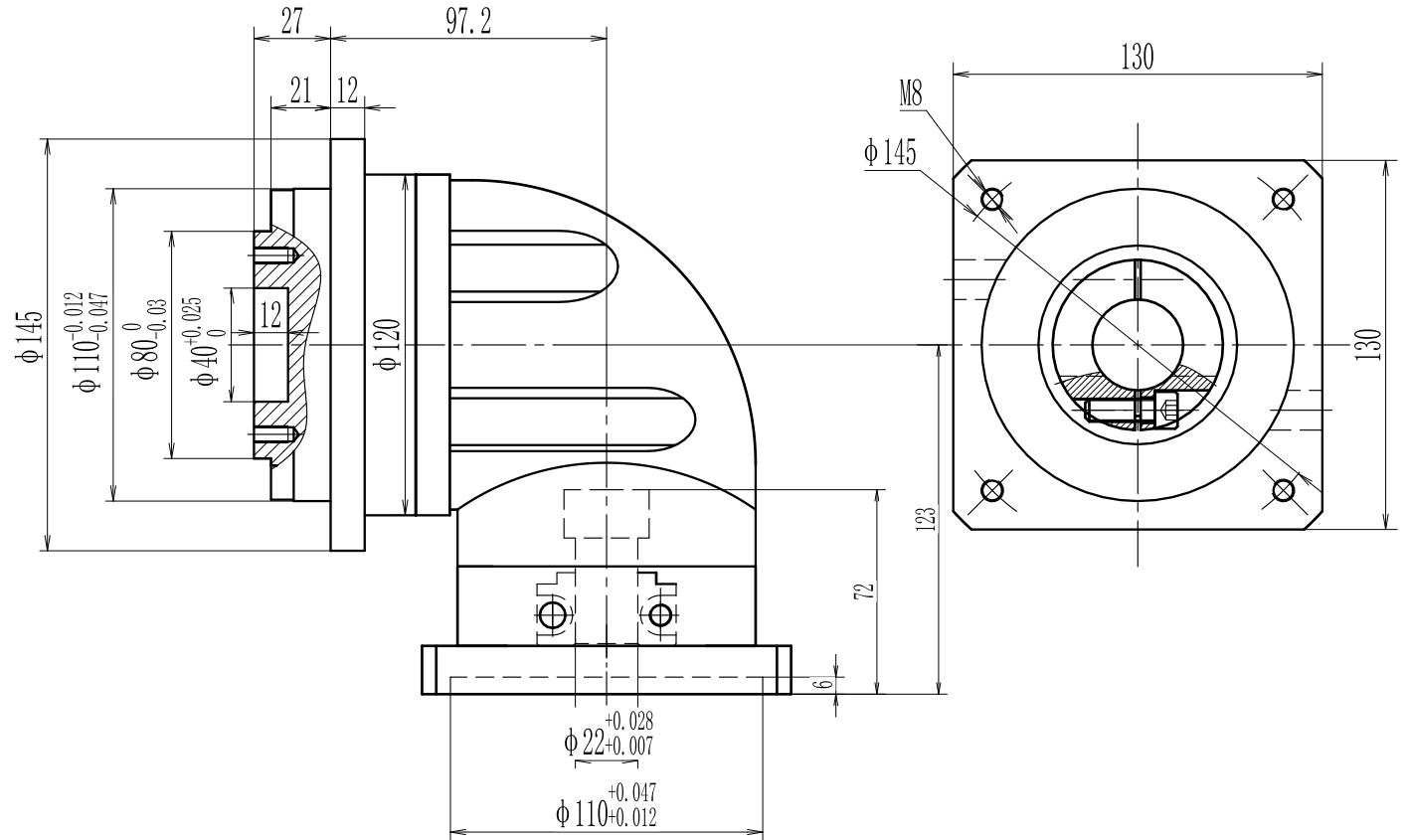

型号 model	EVT110-L1-F-6-130		
速比 ratio	1:4-1:10	承受扭矩 Bear torque	165-320Nm
背隙 precision	6arcmin	输入转速 Input speed	2000r/min
噪音 noise	65dB	重量 weight	12.5kg



帝悦精密科技(苏州)有限公司

YUE DI PRECISION TECHNOLOGY (SUZHOU) CO., LTD.

精密行星减速机

Precision planetary reducer

电话(Call): 0512-53127777

网址(http): WWW.DEU-GAM.COM