

输出轴

输入轴

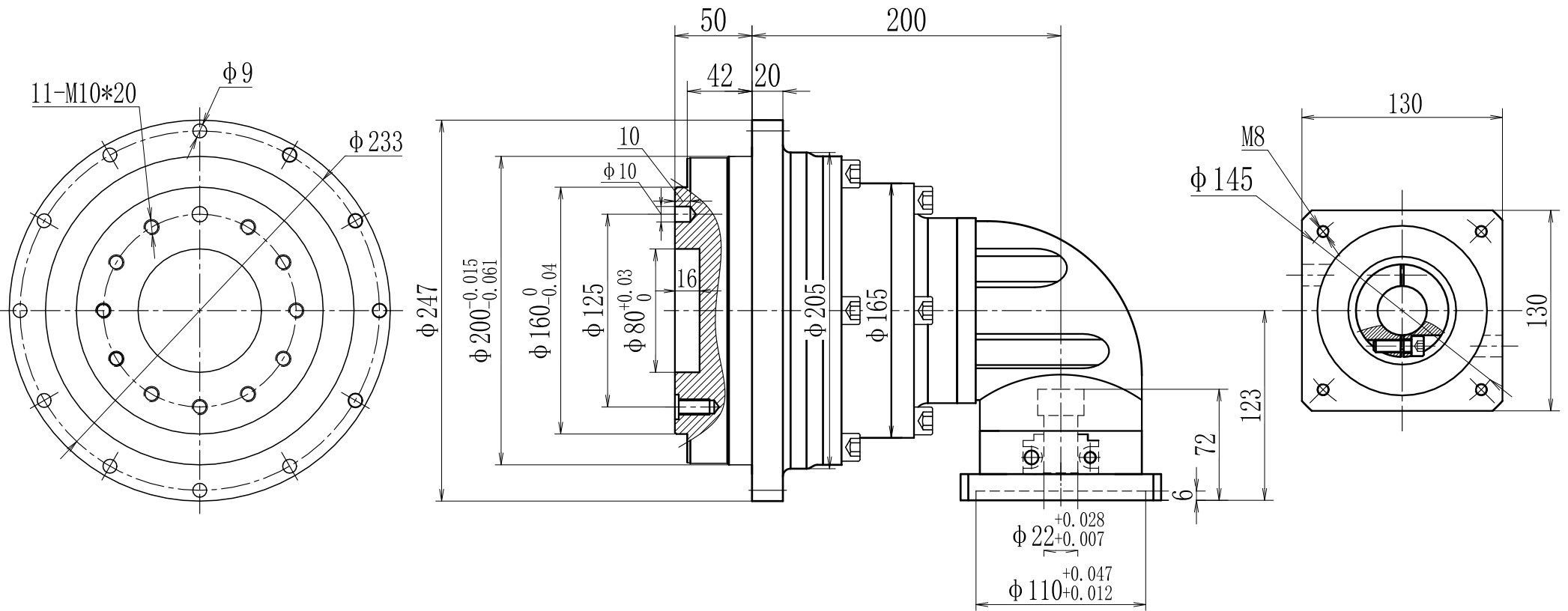

型号 model	EVT200-L3-F-12-130		
速比 ratio	1:64-1:1000	承受扭矩 Bear torque	700-1650Nm
背隙 precision	12arcmin	输入转速 Input speed	2000r/min
噪音 noise	70dB	重量 weight	70kg



帝悦精密科技(苏州)有限公司

YUE DI PRECISION TECHNOLOGY (SUZHOU) CO., LTD.

精密行星减速机

Precision planetary reducer

电话(Call): 0512-53127777

网址(http): WWW.DEU-GAM.COM